

ATELIER

Aufbauanleitung 09/21

WERKZEUG:

Innensechskant Schlüssel SW 5 (beiliegend)

8 x XS Bolzen



8 x Verbindergehäuse



8 x Madenschrauben



Zylinderkopfschrauben (5x70)
mit Unterlegscheiben

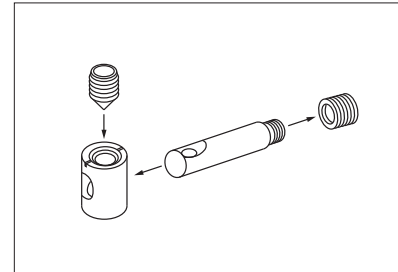
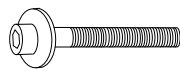

Funktionsvideo:
<http://www.scheulenburg-direkt.de/index.php?page=content&colD=11>

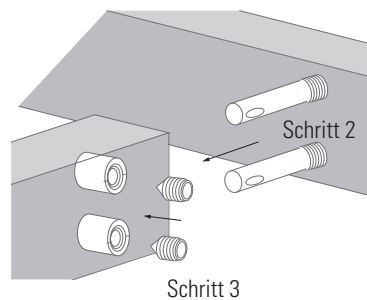
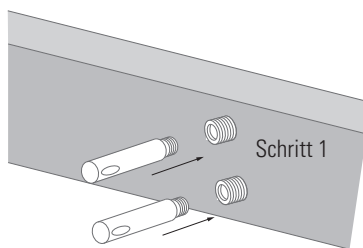

Schritt 4

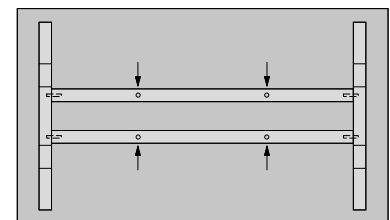

ZUSAMMENBAU DES GESTELLS:

1. Bolzen in Seitenteile schrauben. Die Zargen mit Verbindergehäusen bestücken.
2. Zargen auf die Bolzen stecken.
3. Verbinder mit Madenschraube fixieren.
4. Gestell mit Zylinderkopfschrauben an den Korpus schrauben.

Lässt sich die Madenschraube nicht komplett eindrehen, den XS Bolzen ein Stück herausdrehen und die Madenschraube erneut eindrehen.

BITTE BEACHTEN:

Das Möbel darf nicht geschoben werden. Zum Transport bitte immer an beiden Seiten anheben!

ATELIER

Assembly instructions 09/21

TOOLS:

Allen key SW 5 (enclosed)

8 x XS bolts



8 x connector housings

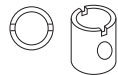

8 x grub screws



cylinder head screws (5x70)
with flat washers

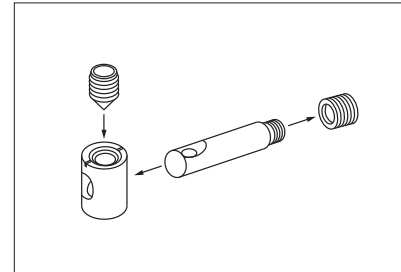
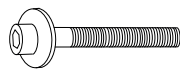

Video:

<http://www.scheulenburg-direkt.de/index.php?page=content&colD=11>

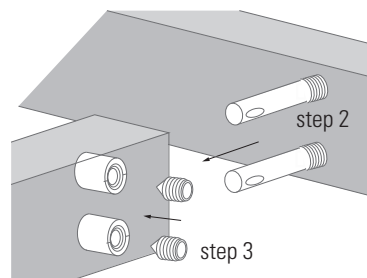
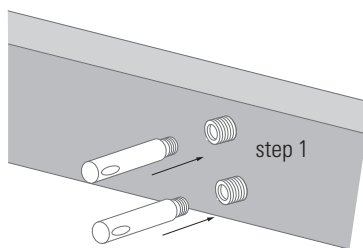

step 4

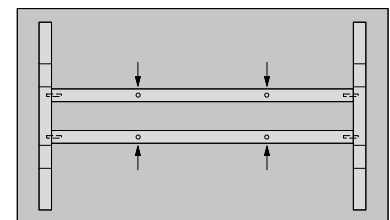

ASSEMBLY OF THE FRAME:

1. Screw the bolts into the sidepieces. Insert the connector housings into the crossbars.
2. Slot the crossbars onto sidepieces.
3. Fix the crossbars with the grub screws.
4. Screw the frame to the bottom side using cylinder head screws.

If you cannot screw in the grub screw flushly, loosen connection and unscrew the bolt slightly. Then connect again.

PLEASE NOTE:

Do not push the piece of furniture. For transport lift both sides!