

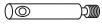





## Aufbauanleitung 05/2021

## WERKZEUG:

Innensechskantschlüssel SW4 und SW5 (beiliegend), Kreuz-Schlitz Schraubendreher

8x XS Bolzen		2x Senkkopfschrauben (5x60)	
8x Verbinder Gehäuse		2x Senkkopfschrauben (5x80)	
8x Madenschrauben		2x MittelfüÙe (13/17 cm), verstellbar	
1x Senkkopfschraube (M8x50)		2x Abstandsklötze	
24x Confirmat Schrauben			

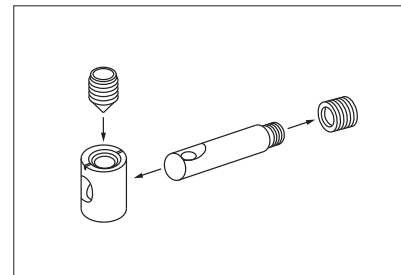

Funktionsvideo:  
<https://www.youtube.com/watch?v=iolUTDqtvGE>

Führen Sie den Aufbau des Bettes **auf einer weichen Unterlage (z.B. einer Decke)** aus, um Beschädigungen zu vermeiden.

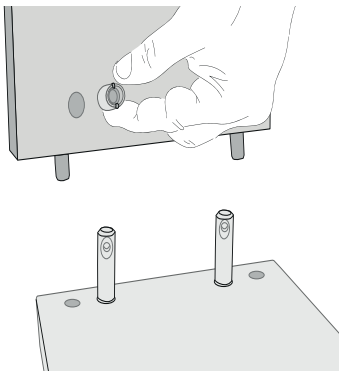

**1.** Bolzen in die Längsseiten eindrehen und Verbindergehäuse in Kopf- und Fußteil einstecken. Bolzen und Gehäuse richtig ausrichten!

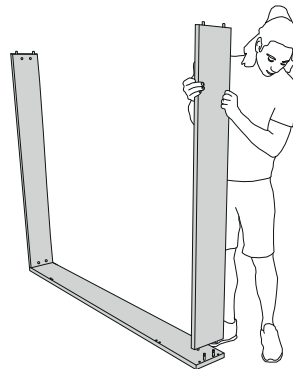

**2.** Kopf- und Fußteil aufstecken und mit Madenschrauben fixieren.

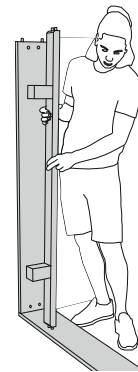

**3.** Die BettfüÙe auf die Quertraversen aufstecken und diese an der Bettseite montieren.

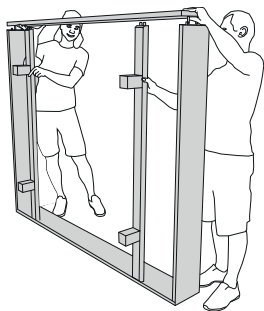

**4.** Zweite Längsseite aufstecken und mit Verbindern fixieren.

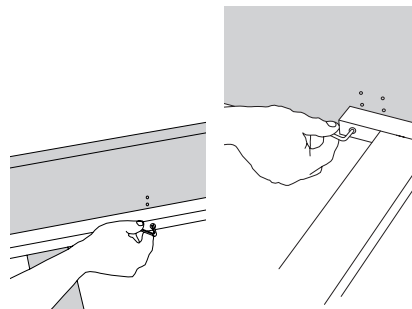

**5.** Seitliche Halteleisten und Mittelsteg mit den Confirmatschrauben befestigen.

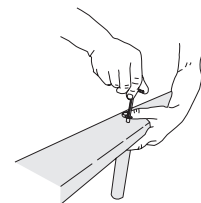

**6.** Einen geeigneten Mittelfuß auswählen und mit der Senkkopfschraube (M8x50) am Mittelsteg montieren. Ca. 1-2 cm niedriger als die übrigen FüÙe einstellen.

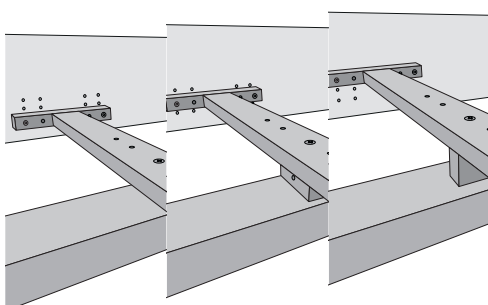

Ohne Abstandsklotz: Einlegetiefe 14,5 cm  
Liegender Abstandsklotz: Einlegetiefe 12,5 cm  
Stehender Abstandsklotz: Einlegetiefe 10,5 cm  
Verwenden Sie die Senkkopfschrauben in der entsprechenden Länge (5x60/80), um den Klotz gegen Herausfallen zu sichern.

## assembly instructions 05/2021

### TOOLS:

allen key SW4 und SW5 (enclosed), crosstip screwdriver

8x XS steel bolts

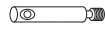

2x countersunk bolts (5x60)



8x connector housings



2x countersunk bolts (5x80)



8x grub screws



2x center feet (13/17 cm), adjustable

1x countersunk bolt (M8x50)



2x distance block

24x confirmat screws

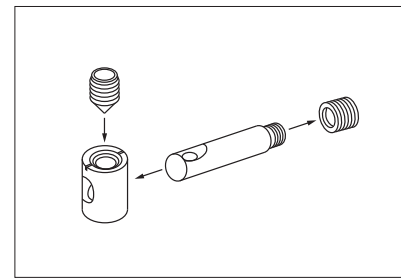
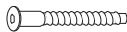

Watch this video for further information on the metal fitting:  
<https://www.youtube.com/watch?v=iolUTDqtvqE>

Please assemble the bed **on a soft surface (e.g. a carpet or blanket)** to avoid damages.

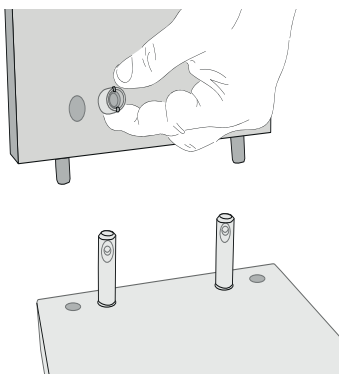

**1.** Screw the bolts into the side rails and insert the connector housing into head and foot sections. Align bolts and housing correctly!

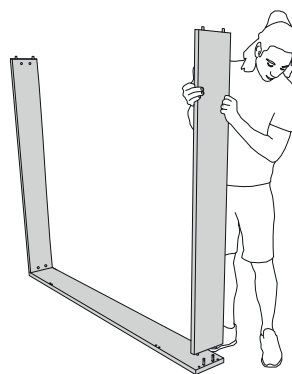

**2.** Attach the head and foot sections and fix them with grub screws.

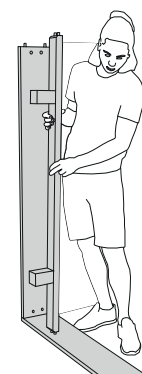

**3.** Attach the two bed feet to the cross-bars and mount them to the bed side.

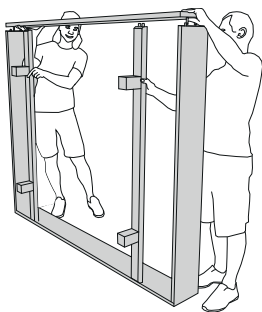

**4.** Connect and fix the second side rail.

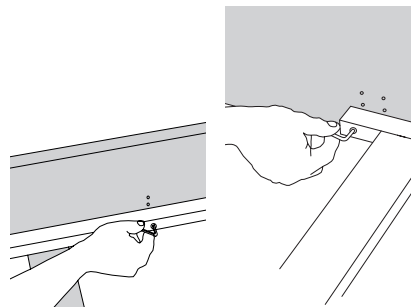

**5.** Fix the side supports using confirmat screws. For mattresses 140 cm or wider, fasten the center rail.

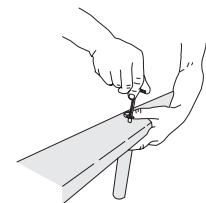

**6.** Choose the correct center feet and connect it to the center rail with the countersunk screw (M8x50). Mind the right length.

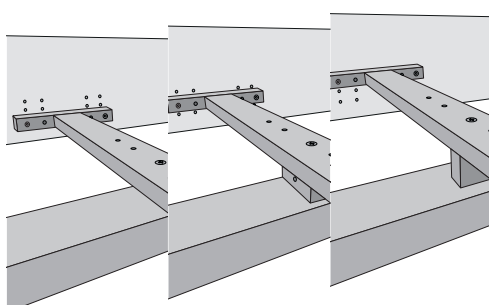

without spacer block: insertion depth 14,5 cm  
 horizontal spacer block: insertion depth 12,5 cm  
 standing spacer block: insertion depth 10,5 cm  
 Use the countersunk screws in the correct length (5x60/80) to fix the spacer block.