

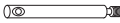





Aufbauanleitung 02/2021

WERKZEUG:

Innensechskantschlüssel SW4 und SW5 (beiliegend)

4 x XS Stahldübel			
8 x XS Stahldübel		12 x Madenschrauben	
12 x Verbinder Gehäuse		3 x Senkkopfschraube (M8x50)	
24 x Confirmat Schrauben		3 x Mittelfüße, verstellbar	

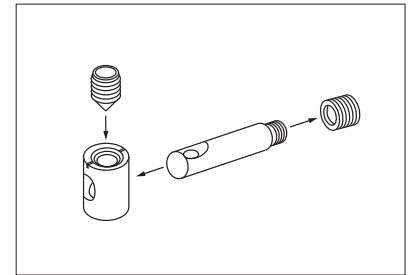

Bitte beachten Sie die Funktionsweise der Beschläge:
<https://www.youtube.com/watch?v=ioLUTDqtvgE>

Führen Sie den Aufbau des Bettes **auf einer weichen Unterlage (z.B. einer Decke)** aus, um Beschädigungen zu vermeiden.

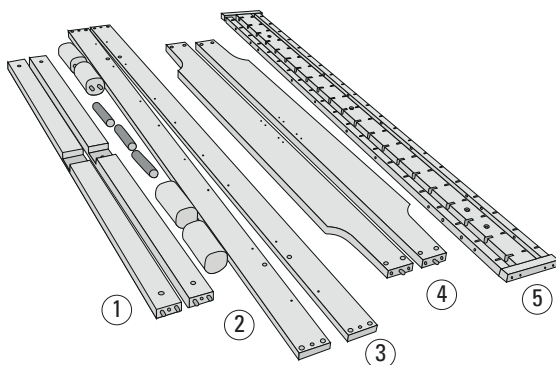

- 1 Quertraversen
- 2 Bettfüße und Mittelfüße
- 3 Längsseiten
- 4 Fuß- und Kopfteil
- 5 Mittelsteg und seitliche Auflageleisten

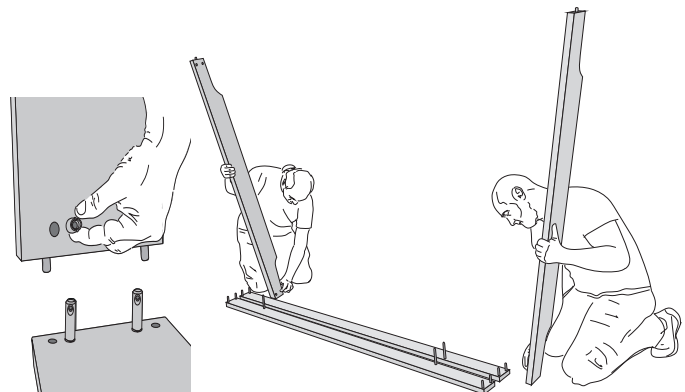

- 1. Drehen Sie alle XS Dübel in die Längsseiten (3) und stecken Sie die Verbinder Gehäuse in das Fuß- sowie Kopfteil (4) und Quertraversen (1). Bolzen und Gehäuse richtig ausrichten! Fuß- und Kopfteil in die Längsseiten stecken und mit Madenschraube fixieren.

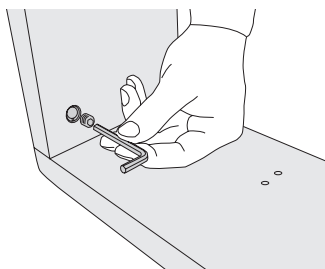

- 2. Drehen Sie mit der Madenschraube die Verbindungen von Längsseite, Fuß- und Kopfteil fest.

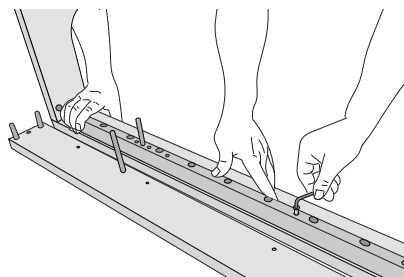

- 3. Montieren Sie die seitlichen Auflageleisten (5) mit den Confirmat Schrauben an den Längsseiten (3).

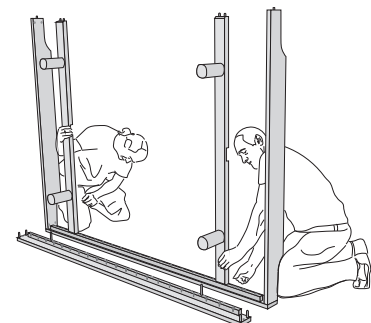

- 4. Stecken Sie nun die zwei Bettfüße (2) auf die Quertraversen (1) und montieren sie diese an der Längsseite (3). Anschließend die zweite Längsseite aufstecken und fixieren.

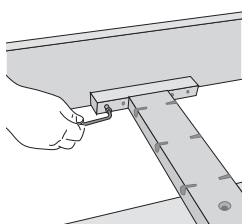

- 5. Stellen Sie das Bett auf die Füße. Anschließend Mittelaufgabeleiste (5) einlegen und festschrauben.

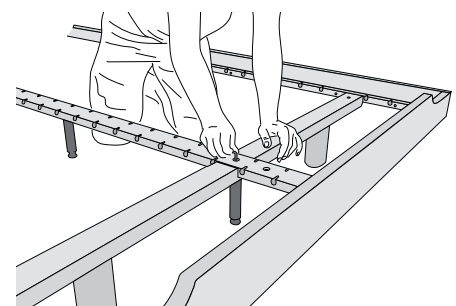
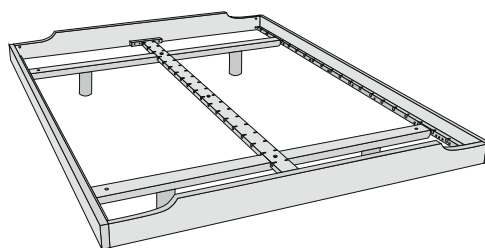

- 6. Schrauben Sie die verstellbaren Mittelfüße (2) mit den Senkkopfschrauben in den Mittelsteg (5). Dabei die richtige Länge beachten.







ECLAIR PETIT

ZEITRAUM

assembly instruction 02/2021

Tools:

Allen screw SW4 and SW5 (enclosed), crosstip screwdriver

4 x XS steel bolts		12 x grub screws	
8 x XS steel bolts		3 x countersunk bolts (M8x50)	
12 x connector housings		3 x adjustable centre feet	
24 x confirmat screws			

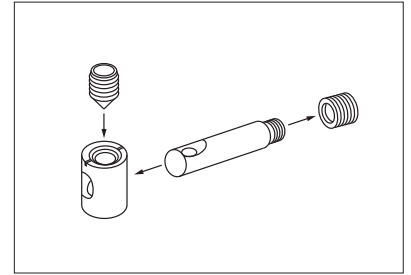

Watch this video for further information on the metal fitting:
<https://www.youtube.com/watch?v=ioiUTDqtvGE>

Please do the setup of the bed **on a soft surface (e.g. a carpet or blanket)** to avoid damages.

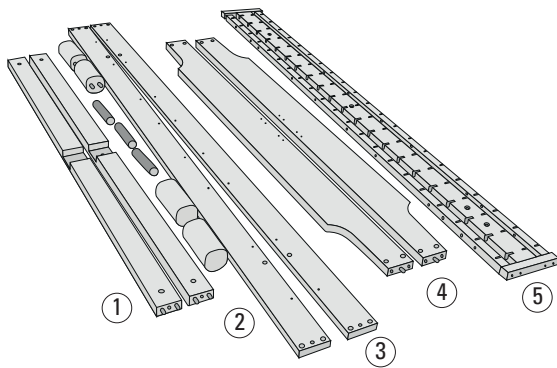

- 1 Crossbars
- 2 Bed feet and centre feet
- 3 Side rails
- 4 Footboard and headboard
- 5 Centre rail and support bars

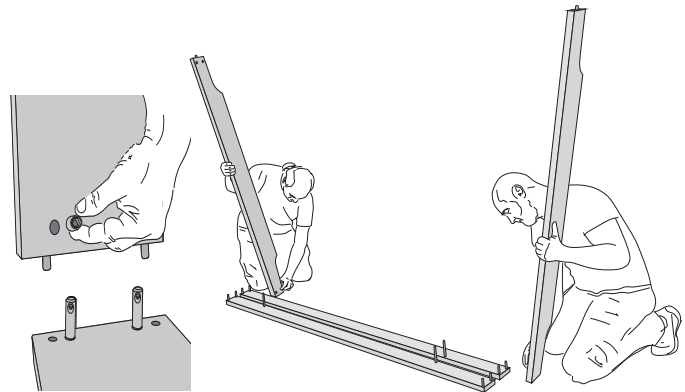

1. Screw all XS bolts into side rails (3) and insert connector housings into the foot and head sections (4) and crossbars (1). Align the bolts and housings correctly! Mount foot and headboards to the side rails and fix them with grub screws.

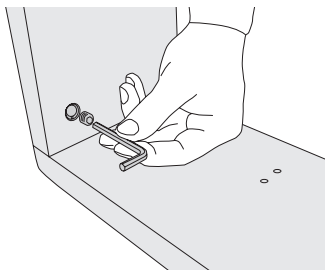

2. Use the grub screw to tighten the connections of side rail, foot and headboard.

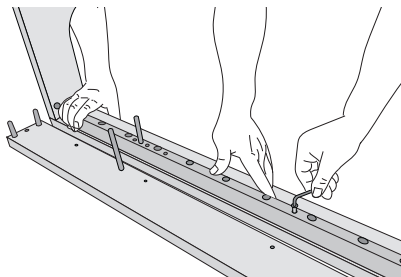

3. Mount the support bars (5) on the side rails (3) using confirmat screws.

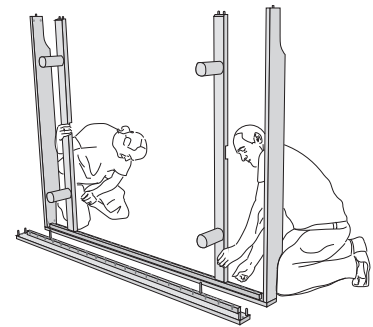

4. Now place the two bed feet (2) on the crossbars (1) and mount those to the side rail (3). Then attach the second side rail and fix it in place.

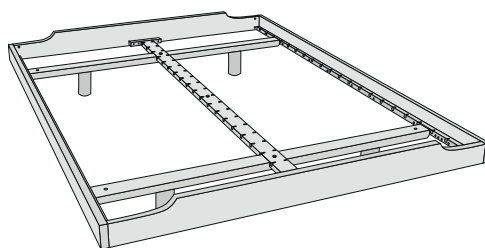
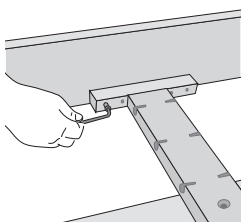

5. Place bed on its feet. Then insert the centre rail (5) and screw it in place.

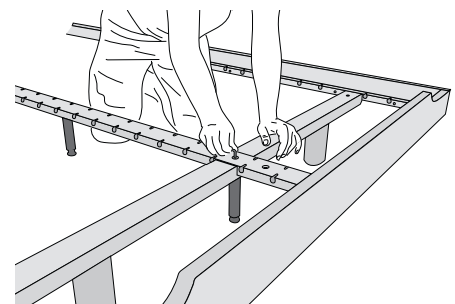

6. Mount the adjustable centre feet (2) to the centre rail (5) using countersunk screws. Mind the correct length.